

# HANDLEBAR-PACK FLEX

**ORTLIEB** WATERPROOF

- DE MONTAGEANLEITUNG
- GB ASSEMBLY INSTRUCTIONS
- FR INSTRUCTIONS DE MONTAGE
- IT ISTRUZIONI DI MONTAGGIO
- NL MONTAGE HANDLEIDING
- DK MONTERINGSVEJLEDNING
- ES INSTRUCCIONES DE MONTAJE
- SE MONTERINGSANVISNING
- NO MONTERINGSANVISNING
- FI ASENNUSOHJEET
- PL INSTRUKCJA MONTAZU
- JP 装着方法

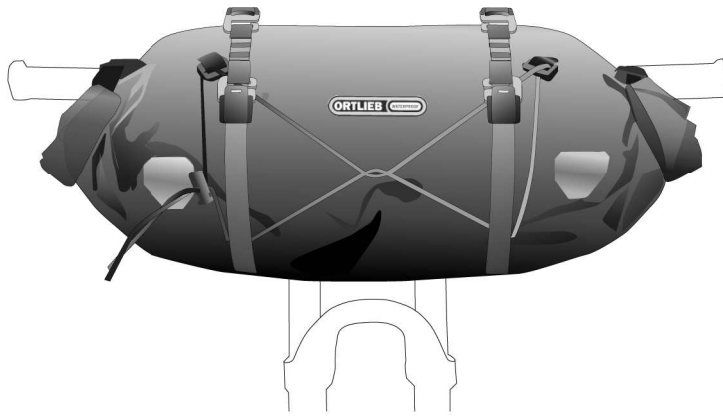

**VIDEO**



**! MOUNTING-SET REQUIRED**

**HANDLEBAR MOUNTING-SET QR**

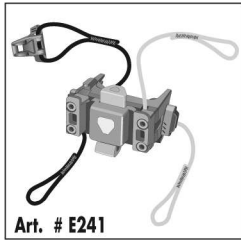

**HANDLEBAR MOUNTING-SET**

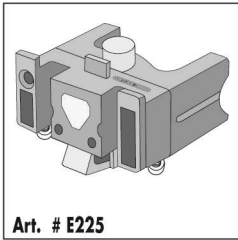

**HANDLEBAR MOUNTING-SET WITH LOCK**

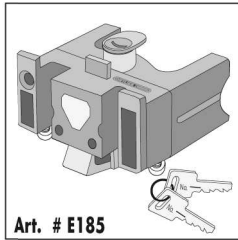

**HANDLEBAR MOUNTING-SET E-BIKE**

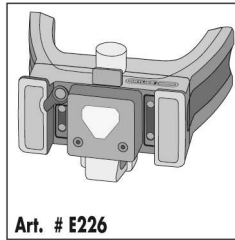

**HANDLEBAR MOUNTING-SET E-BIKE WITH LOCK**

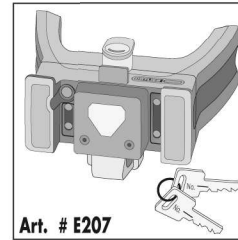

**BAR-LOCK-MOUNTING-SET**

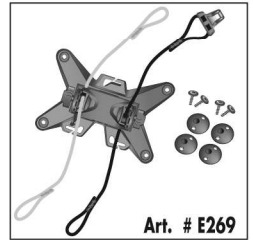

**MOUNT**

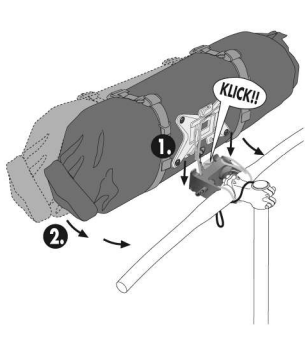

**DEMOUNT**

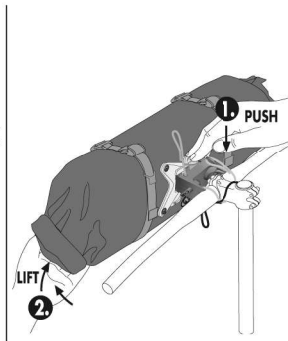

**! MAX. LOAD**



**!**

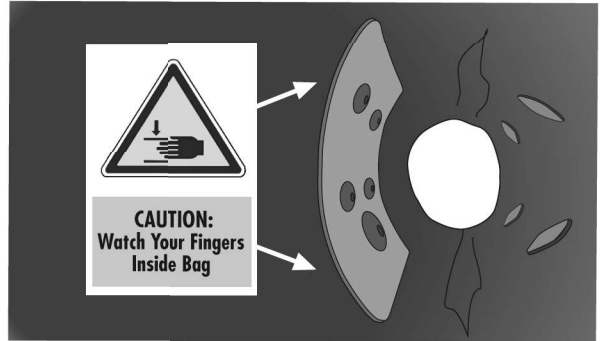

**PACKING**

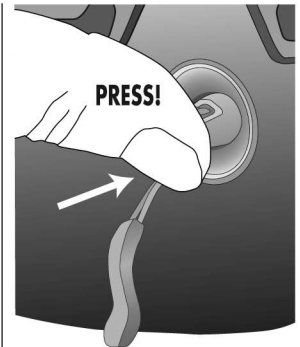
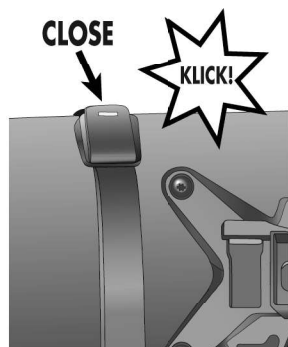
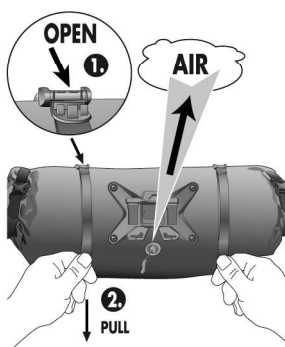
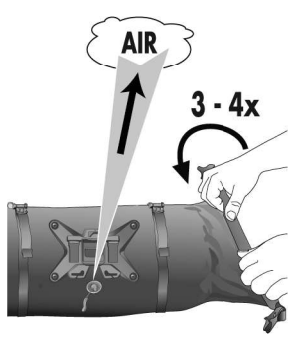
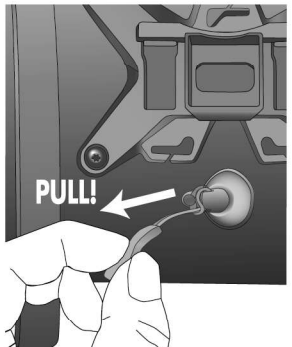

**! = NO JUMP!**



**!**



**! CHECK SECURE MOUNT**



**ACCESSORIES**



WEITERE INFORMATIONEN:  
MORE INFORMATION:



www.ortlieb.com